



■ Made
■ in
■ Germany



Softsynchro® QuickLock

EMUGE

Schnellwechsel-Aufnahmen mit bewährter Softsynchro®-Technologie
Quick-Change Tap Holders with Proven Softsynchro® Technology

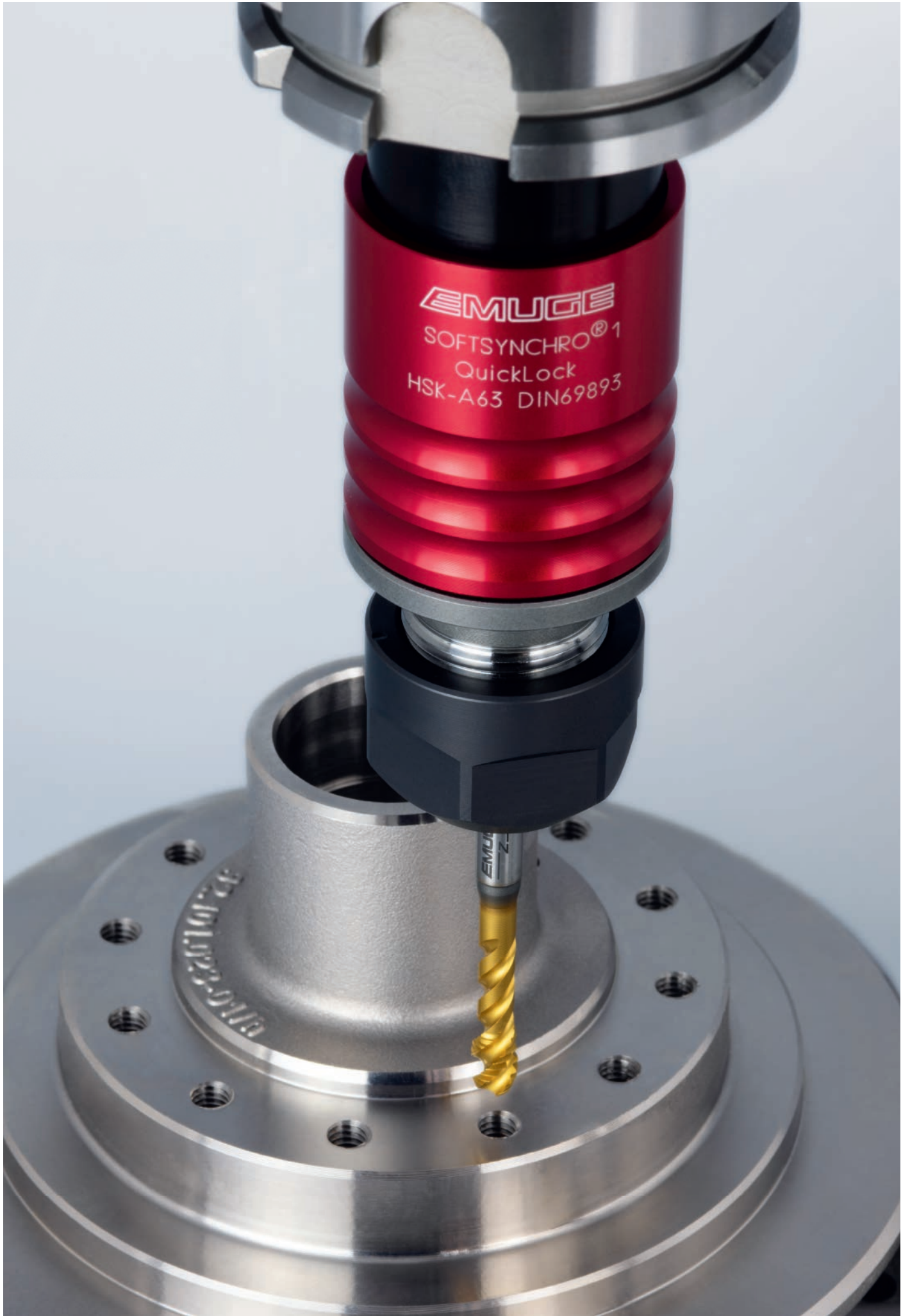

Softsynchro® QuickLock

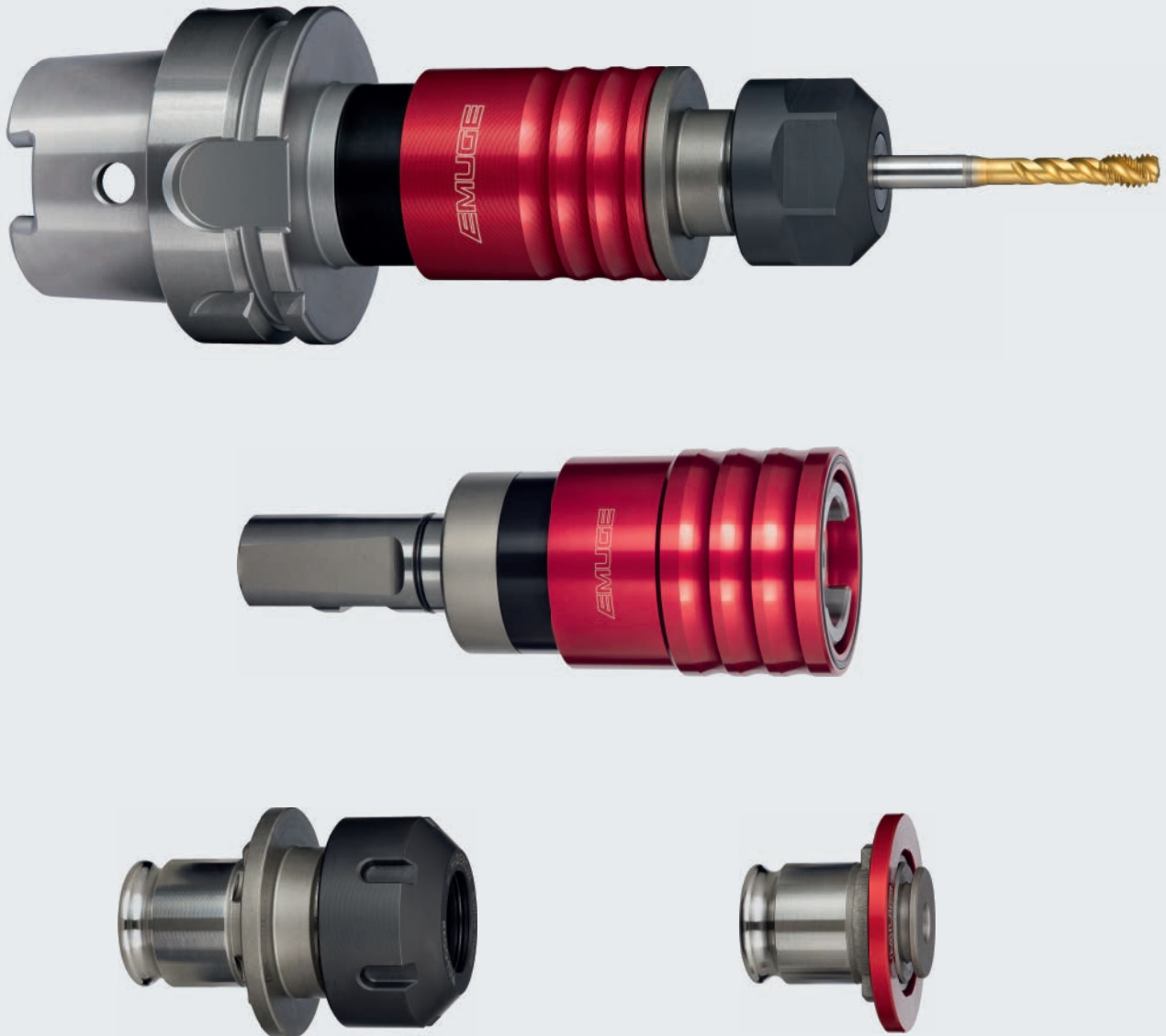
**Spezifikationen:**

- Austausch des Schnellwechsel-Einsatzes ohne zusätzliches Werkzeug
- Abgedichtete Griffbüchse, die die Schnellwechsel-Aufnahme vor Spänen und Emulsion schützt
- Spannung des Gewindewerkzeuges unabhängig vom Werkzeughalter
- Im Bearbeitungszentrum ist ein werkzeugloser Wechsel der im Schnellwechsel-Einsatz montierten Gewindewerkzeuge möglich
- Eingeeengtes radiales Spiel zwischen Schnellwechsel-Einsatz und Schnellwechsel-Aufnahme
- In Verbindung mit den Schnellwechsel-Einsätzen EM/QuickLock und EM-Z/QuickLock ist die Schnellwechsel-Aufnahme axial und radial hermetisch gegen Verschmutzung abgedichtet
- Der Schnellwechsel-Einsatz Typ EM-Z/QuickLock mit Spannzanze ermöglicht eine Längenvoreinstellung der Gewindewerkzeuge
- Bewährte Softsynchro®-Technologie
- Kompatibel zu allen handelsüblichen Einsätzen

Specifications:

- Change of the quick-change adapter without additional tool
- Sealed grip sleeve which protects the quick-change tap holder against chips and emulsion
- Clamping of the threading tool independent of tool holder
- The threading tools clamped in the quick-change adapter can be changed without tools in the machining centre
- Reduced radial backlash between quick-change adapter and quick-change tap holder
- The quick-change tap holder combined with quick-change adapters EM/QuickLock and EM-Z/QuickLock is axially and radially hermetically sealed against dirt
- The quick-change adapter type EM-Z/QuickLock with collet enables a length preadjustment of the threading tools
- Proven Softsynchro® technology
- Compatible with all commercial adapters

Softsynchro® QuickLock

DIN 69893 A



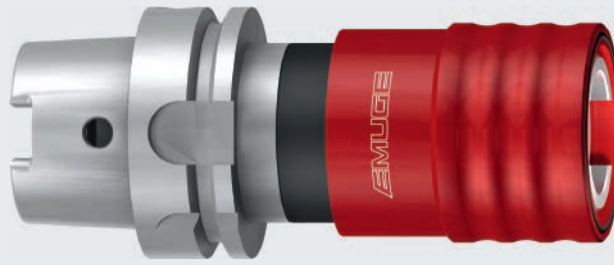

p_{max}
50bar
(700psi)

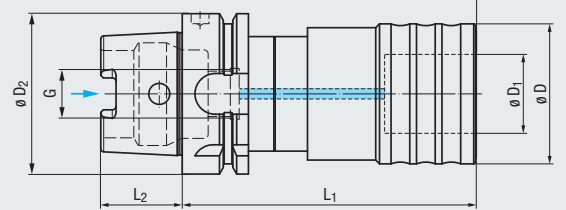

Mit Bohrung für Datenträger DIN 69873
With bore for data chip according to DIN 69873



Einsatz auf Maschinen mit Synchronspindel For use on machines with synchronous spindle

Typ Type			$\varnothing D_2$	$\varnothing D$	$\varnothing D_1$	L_1	L_2	G	C	T	Artikel-Nr. Article no.	
Softsynchro® 1 QuickLock	M4 - M12	EM 01(-Z)/QuickLock	HSK-A63	39	19	90	32	M18 x 1	0,5	0,5	F3601C04.1	●
			HSK-A100	39	19	96	50	M24 x 1,5	0,5	0,5	F3601C06.1	●
Softsynchro® 3 QuickLock	M8 - M20	EM 03(-Z)/QuickLock	HSK-A63	55	31	115	32	M18 x 1	0,5	0,5	F3603C04.1	●
			HSK-A100	55	31	122	50	M24 x 1,5	0,5	0,5	F3603C06.1	●

Weitere Ausführungen auf Anfrage
Further designs upon request

Zubehör

Accessories



Schnellwechsel-Einsätze EM/QuickLock
Quick-change adapters EM/QuickLock **» 6**



Schnellwechsel-Einsätze EM-Z/QuickLock
Quick-change adapters EM-Z/QuickLock **» 7**



Kühlschmierstoffrohre und Schlüssel
Coolant tubes and wrenches

Softsynchro® QuickLock

DIN 1835 B+E



IKZ

p_{max}
50bar
(700psi)

C T
Soft

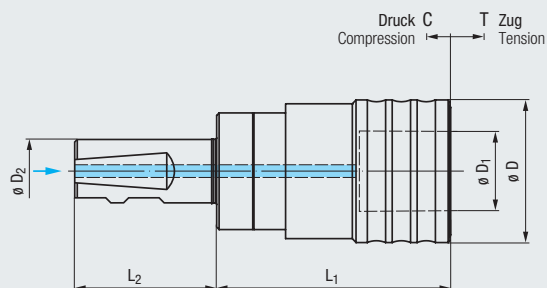

Einsatz auf Maschinen
mit Synchronspindel

For use on machines
with synchronous spindle

Typ Type			$\varnothing D_2$	$\varnothing D$	$\varnothing D_1$	L_1	L_2	C	T	Artikel-Nr. Article no.	
Softsynchro® 1 QuickLock	M4 - M12	EM 01(-Z)/QuickLock	20	39	19	67	51	0,5	0,5	F3601G25.1.44	●
			25	39	19	67	57	0,5	0,5	F3601G26.1.44	●
Softsynchro® 3 QuickLock	M8 - M20	EM 03(-Z)/QuickLock	25	55	31	94	57	0,5	0,5	F3603G26.1.44	●

Weitere Ausführungen auf Anfrage
Further designs upon request

Zubehör Accessories



Schnellwechsel-Einsätze EM/QuickLock
Quick-change adapters EM/QuickLock ▶ 6





Schnellwechsel-Einsätze EM-Z/QuickLock
Quick-change adapters EM-Z/QuickLock ▶ 7



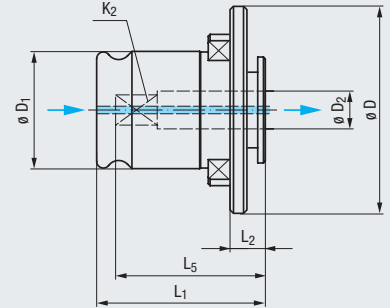
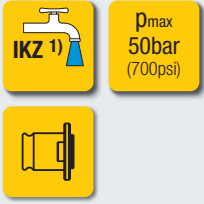

Adaptionsschäfte
Adapter shanks

EM/QuickLock



Typ · Type	EM 01-QuickLock	EM 03-QuickLock
	M4 - M12	M8 - M20
$\varnothing D$	39	55
$\varnothing D_1$	19	31
L_1	29	45
L_2	7	10

DIN				Artikel-Nr. Article no.	L_5		Artikel-Nr. Article no.	L_5	
$\varnothing D_2$	K_2								
4,5	3,4	M4	M6	F4521104.6	23	●			
6	4,9	M4,5 - M6	M8	F4521106.6	25	●			
7	5,5	M7	M9 - M10	F4521107.6	25	●			
8	6,2	M8	M11	F4521108.6	26	●	F4523108.6	38	●
9	7	M9	M12	F4521109.6	27	●	F4523109.6	39	●
10	8	M10		F4521110.6	27	●	F4523110.6	40	●
11	9		M14				F4523111.6	41	●
12	9		M16				F4523112.6	41	●
14	11		M18				F4523113.6	43	●
16	12		M20				F4523114.6	44	●

1) Bei Verwendung von Gewindebohrern / Gewindeformern mit innerer Kühlschmierstoff-Zufuhr
If used with taps / cold-forming taps with internal coolant supply

Weitere Größen auf Anfrage
Further sizes upon request

Großer Griffiring ermöglicht stirnseitige Abdichtung
Large ring handle enables sealing of the front face

EM-Z/QuickLock

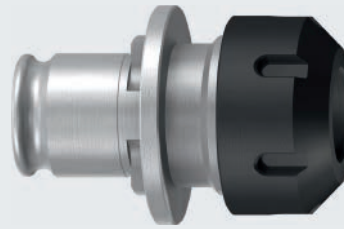
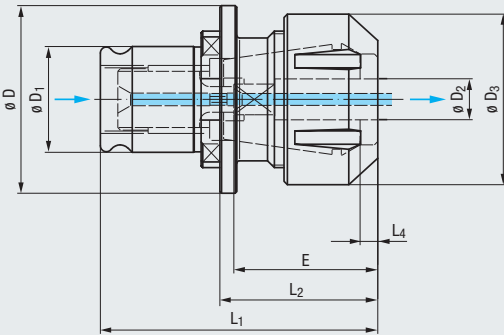

p_{max}
50bar
(700psi)

L+ 2 mm

Typ Type		$\varnothing D_2$			$\varnothing D$	$\varnothing D_1$	$\varnothing D_3$	L_1	L_2	L_4	Artikel-Nr. Article no.	
EM 01-Z/QuickLock	M4,5 - M10	6 / 7	ER 20 (GB)	Hi-Q/ERC 20	39	19	34	61	39,5	5	F4511001.6D6	●
	M8 - M12	8 / 9			39	19	34	61	39,5	5	F4511001.6D8	●
	M10	10			39	19	34	61	39,5	5	F4511001.6D10	●
EM 03-Z/QuickLock	M8 - M12	8 / 9	ER 32 (GB)	Hi-Q/ERC 32	55	31	50	81,5	46,5	5	F4513001.6D8	●
	M10 - M16	10 - 12			55	31	50	81,5	46,5	5	F4513001.6D10	●
	M18 - M20	14 - 16			55	31	50	81,5	46,5	5	F4513001.6D14	●

1) Bei Verwendung von Gewindebohrern / Gewindeformern mit innerer Kühlschmierstoff-Zufuhr
If used with taps / cold-forming taps with internal coolant supply

Weitere Ausführungen auf Anfrage
Further designs upon request

Längeneinstellschraube sowie Spannmutter für Dichtscheiben sind im Lieferumfang enthalten
Length adjustment screw as well as clamping nut for sealing disks are included in the delivery

Großer Griffiring ermöglicht stirnseitige Abdichtung
Large ring handle enables sealing of the front face

Zubehör Accessories

Spannzangen Typ ER (GB)
Collets type ER (GB)

Dichtscheiben Typ DS/ER
Sealing disks type DS/ER

Aufnahmekopf AEU
Adapter head AEU

Kühlscheiben Typ KS/ER
Coolant flush disks type KS/ER

Einstecktiefen E Clamping depths E

Spannzangen Collets				ER 20 GB	ER 32 GB
Spannmuttern Clamping nuts				Hi-Q/ERC 20	Hi-Q/ERC 32
DIN					
$\varnothing D_2$	K_2			E	E
6	4,9	M4,5 - M6	M8	31	
7	5,5	M7	M9 - M10	31	
8	6,2	M8	M11	36	36
9	7	M9	M12	37	37
10	8	M10		41	41
11	9		M14		42
12	9		M16		42
14	11		M18		44
16	12		M20		45

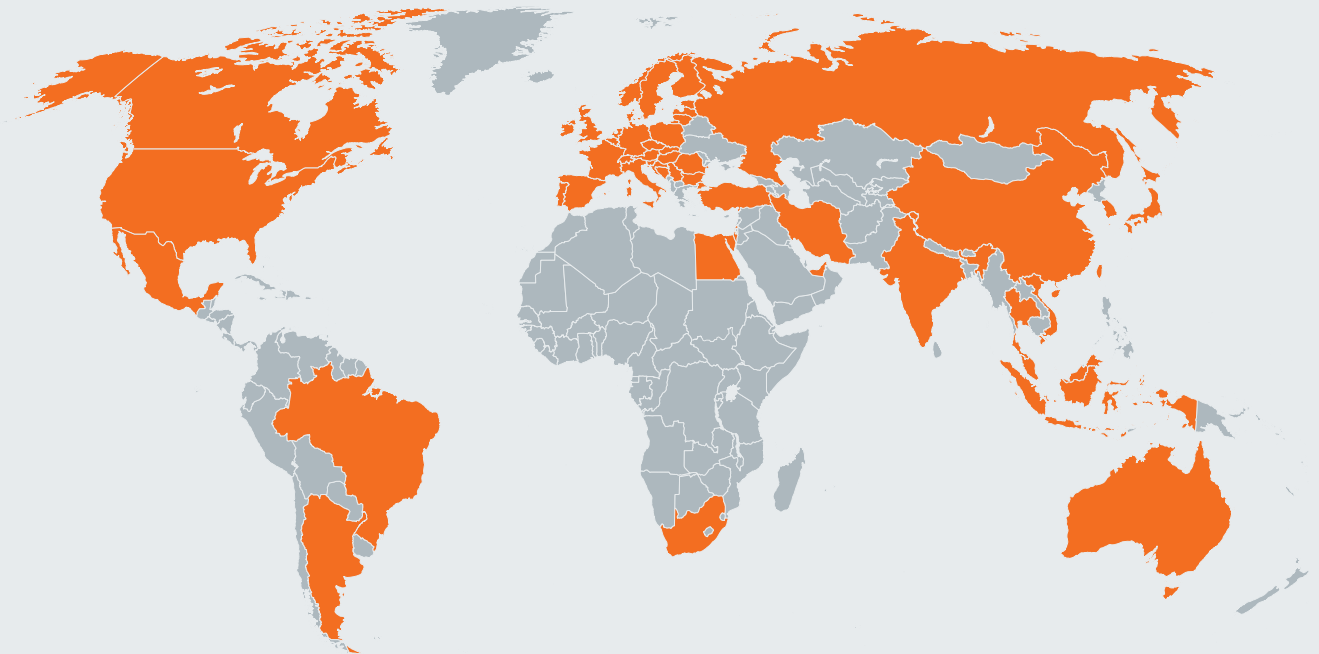

EMUGE-FRANKEN Vertriebspartner finden Sie auf www.emuge-franken.com/vertrieb
EMUGE-FRANKEN sales partners, please see www.emuge-franken.com/sales

EMUGE-Werk Richard Glimpel GmbH & Co. KG
Fabrik für Präzisionswerkzeuge

🏠 Nürnberger Straße 96-100
91207 Lauf
GERMANY

☎ +49 9123 186-0
📠 +49 9123 14313

FRANKEN GmbH & Co. KG
Fabrik für Präzisionswerkzeuge

🏠 Frankenstraße 7/9a
90607 Rückersdorf
GERMANY

☎ +49 911 9575-5
📠 +49 911 9575-327

✉ info@emuge-franken.com 🌐 www.emuge-franken.com